

YASKAWA AC Drive GA700

High Performance Type

Initial Steps

Type: CIPR-GA70Cxxxxxxxx
Models: 200 V class: 0.55 to 110 kW
400 V class: 0.55 to 355 kW

To properly use the product, read this manual thoroughly and retain for easy reference, inspection, and maintenance. Ensure the end user receives this manual.

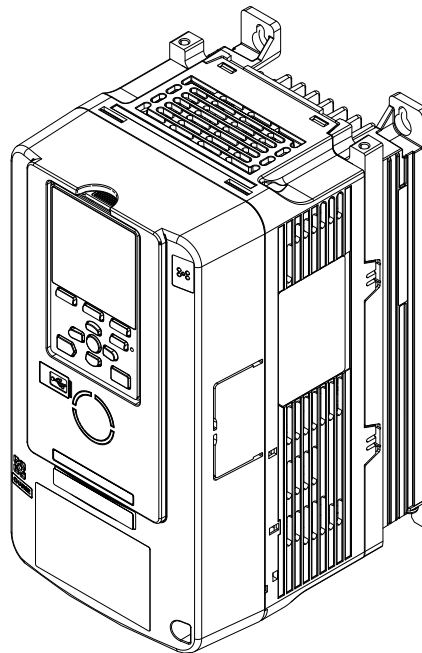

1 General Information

Do not use this manual as a replacement for the Technical Manual. The products and specifications given in this manual and the manual contents can change without notice to make the product and manual better. Be sure to always use the most recent version of this manual. Use the manual for the correct installation, wiring, adjustment, and operation of this product.

This manual is available for download on our documentation website. Refer to the back page of this manual.

2 Qualifications for the Intended User

Yaskawa created this manual for electrical specialists and engineers who have experience with AC drive installation, adjustment, repair, inspection, and parts replacement. Persons without technical training, minors, persons with disabilities or mental problems, persons with perception problems, and persons with pacemakers must not use or operate this product.

3 Safety

Read the safety guidelines carefully before installing, wiring, or operating this product.

◆ Explanation of Signal Words

▲ DANGER Indicates a hazardous situation, which, if not avoided, will cause death or serious injury.

▲ WARNING Indicates a hazardous situation, which, if not avoided, could cause death or serious injury.

▲ CAUTION Indicates a hazardous situation, which, if not avoided, could cause minor or moderate injury.

NOTICE Indicates a property damage message.

◆ General Safety Instructions

Yaskawa Electric manufactures and supplies electronic components for a variety of industrial applications. The selection and application of Yaskawa products is the responsibility of the designer of the equipment or the customer that assembles the final product. Yaskawa is not responsible for how our products are incorporated into the final system design. In all cases, Yaskawa products should not be incorporated into a product or design as the exclusive or sole safety control function. All control functions are designed to dynamically detect failures and operate safely without exception. All products that are designed to incorporate parts manufactured by Yaskawa must be provided to the end user and include proper warnings and instructions regarding their safe use and operation. All warnings from Yaskawa must be promptly issued to the end user. Yaskawa offers warranties only for the quality of our products, in compliance with standards and specifications that are described in the manual. Yaskawa does not offer other warranties, either explicit or implied. Injuries, property damage, and lost business opportunities caused by improper storage or handling and negligence oversight on the part of your company or your customers will void Yaskawa's warranty for the product.

Note:

Failure to obey the safety messages in the manual can cause serious injury or death. Yaskawa is not responsible for injuries or damage to equipment caused by ignoring the safety messages.

- Read this manual carefully when mounting, operating, and repairing AC drives.
- Obey all warnings, cautions, and notices.
- Approved personnel must perform all work.
- Install the drive in an area with these conditions.

▲ DANGER *Electrical Shock Hazard. Do not examine, connect, or disconnect wiring on an energized drive. Before servicing, disconnect all power to the equipment and wait for the time specified on the warning label at a minimum. The internal capacitor stays charged after the drive is de-energized. The charge indicator LED extinguishes when the DC bus voltage decreases below 50 Vdc. When all indicators are OFF, remove the covers before measuring for dangerous voltages to make sure that the drive is safe. Failure to obey will cause death or serious injury.*

▲ WARNING *Fire Hazard. Do not connect power supply wiring to drive output terminals U/T1, V/T2, and W/T3. Connect power supply wiring to main circuit input terminals R/L1, S/L2, and T/L3. Failure to obey can cause death or serious injury.*

▲ WARNING *Crush Hazard. Only approved personnel can operate a crane or hoist to move the drive. Failure to obey can cause death or serious injury from falling equipment.*

▲ WARNING *Electrical Shock Hazard. Do not make changes to the drive body or drive circuitry. Failure to obey can cause death or serious injury and will void warranty. Yaskawa is not responsible for changes to the product made by the user.*

- ⚠ WARNING** *Electrical Shock Hazard. Only let authorized persons install, wire, maintain, examine, replace parts, and repair the drive. Failure to obey can cause death or serious injury.*
- ⚠ WARNING** *Electrical Shock Hazard. Always ground the motor-side grounding terminal. Contacting the motor case can cause death or serious injury from incorrect equipment grounding.*
- ⚠ WARNING** *Electrical Shock Hazard. Do not work on the drive or around the drive while wearing loose clothing or jewelry. Tighten loose clothing and remove all metal objects such as watches or rings. Failure to obey can cause death or serious injury.*
- ⚠ WARNING** *Electrical Shock Hazard. The leakage current of drive models 4389A to 4675A, 2xxxB/C and 4xxxB/C is more than 3.5 mA. The IEC/EN 61800-5-1: 2007 standard specifies that users must wire the power supply to automatically turn off when the protective ground wire disconnects. Users can also connect a protective ground wire that has a minimum cross-sectional area of 10 mm² (copper wire) or 16 mm² (aluminum wire). Failure to obey these standards can cause death or serious injury.*
- ⚠ WARNING** *Sudden Movement Hazard. Remove all persons and objects from the area around the drive, motor, and load before starting Auto-Tuning. The drive and motor can start suddenly during Auto-Tuning and cause death or serious injury.*
- ⚠ WARNING** *Sudden Movement Hazard. Remove all persons and objects from the area around the drive, motor, and machine area and attach covers, couplings, shaft keys, and machine loads before energizing the drive. Failure to obey can cause death or serious injury.*
- ⚠ WARNING** *Fire Hazard. Do not use the main circuit power supply (Overcurrent Category III) at incorrect voltages. Make sure that the drive rated voltage aligns with the power supply voltage before energizing the drive. Failure to obey can cause death or serious injury.*
- ⚠ WARNING** *Fire Hazard. Do not put flammable or combustible materials on top of the drive and do not install the drive near flammable or combustible materials. Attach the drive to metal or other noncombustible material. Failure to obey can cause death or serious injury.*
- ⚠ WARNING** *Fire Hazard. Tighten all terminal screws to the correct tightening torque. Connections that are too loose or too tight can cause incorrect operation and damage to the drive. Incorrect connections can also cause death or serious injury from fire.*
- ⚠ WARNING** *Crush Hazard. Use a lifting mechanism made to move large drives when necessary. Failure to obey can cause death or serious injury from falling equipment.*
- ⚠ WARNING** *Electrical Shock Hazard. Do not cause a short circuit on the drive output circuit. Failure to obey can cause death or serious injury.*
- ⚠ WARNING** *Electrical Shock Hazard. Use a type B Residual Current Monitor/Residual Current Device (RCM/RCD) for protection against contact when using a residual current operated protective device or monitoring device as specified by IEC/EN 60755. The drive can cause a residual current with a DC component in the protective earthing conductor. Failure to obey can cause death or serious injury.*
- ⚠ WARNING** *Electrical Shock Hazard. Ground the neutral point on the power supply of drive models 2xxxB/C and 4xxxA/B/C to comply with the EMC Directive before turning on the EMC filter or if there is high resistance grounding. Failure to obey can cause death or serious injury.*
- ⚠ WARNING** *Electrical Shock Hazard. Do not immediately energize the drive or operate peripheral devices after the drive blows a fuse or trips an RCM/RCD. Wait for the time specified on the warning label at a minimum and make sure that all indicators are OFF. Then check the wiring and peripheral device ratings to find the cause of the problem. Contact Yaskawa before energizing the drive or peripheral devices if the cause is not known. Failure to obey can cause death or serious injury and damage to the drive.*
- ⚠ WARNING** *Fire Hazard. Install sufficient branch circuit short circuit protection as specified by applicable codes and this manual. The drive is suited for circuits that supply not more than 100,000 RMS symmetrical amperes, 240 Vac maximum (200 V Class), 480 Vac maximum (400 V Class). Failure to obey can cause death or serious injury.*
- ⚠ CAUTION** *Crush Hazard. Do not hold the drive by the front cover or terminal cover. Tighten the screws correctly before moving the drive. Failure to obey can cause minor to moderate injury.*
- ⚠ CAUTION** *Burn Hazard. Do not touch a hot drive heatsink. De-energize the drive, wait 15 minutes minimum, and make sure that the heatsink is cool to replace the cooling fans. Failure to obey can cause minor to moderate injury.*
- NOTICE** *Observe correct electrostatic discharge (ESD) procedures when touching the drive and circuit boards. Failure to obey can cause ESD damage to the drive circuitry.*
- NOTICE** *Do not connect or disconnect the motor from the drive while the drive is supplying voltage. Incorrect equipment sequencing can cause damage to the drive.*
- NOTICE** *Do not do a withstand voltage test or Megger test on the drive. Failure to obey can cause damage to the drive.*
- NOTICE** *Do not connect or operate damaged equipment or equipment with missing parts. Failure to obey can cause damage to the drive and connected equipment.*
- NOTICE** *Install fuses and an RCM/RCD. Failure to obey can cause damage to the drive.*
- NOTICE** *Do not use unshielded wire for control wiring. Use shielded, twisted-pair wires and ground the shield to the ground terminal of the drive. Failure to obey can cause electrical interference and unsatisfactory system performance.*

4 Moving the Drive

NOTICE Review the *Braking Unit and Braking Resistor Unit Installation Manual TOBPC72060001* before connecting a dynamic braking option to the drive. Failure to obey can cause damage to the drive and braking circuit.

NOTICE Make sure that all connections are correct after installing the drive and connecting peripheral devices. Failure to obey can cause damage to the drive.

NOTICE Do not connect phase-advancing capacitors or LC/RC noise filters to the output circuits. Failure to obey can cause damage to the drive, phase-advancing capacitors, LC/RC noise filters, and leakage breakers (ELCB, GFCI, or RCM/RCD).

◆ Intended Use

This AC drive is electrical equipment that controls the speed and rotational direction of a motor in a commercial application. Do not use this product for other functions.

1. Read and understand all safety precautions.
2. Wire and ground the drive as specified by all applicable standards and safety precautions.
3. Tightly attach all parts and protective covers.
4. Always use the product in the correct environmental conditions as specified in this manual.

⚠ DANGER *Electrical Shock Hazard. Make sure that all electrical connections are correct and install all drive covers before energizing the drive. Use terminals for their intended function only. Incorrect wiring or ground connections, and incorrect repair of protective covers can cause death or serious injury.*

⚠ WARNING *Electrical Shock Hazard. Do not make changes to the drive body or drive circuitry. Failure to obey can cause death or serious injury and will void warranty. Yaskawa is not responsible for changes to the product made by the user.*

◆ Warranty and Exclusion of Liability

- This product is not designed and manufactured for use in life-support machines or systems.
- Contact a Yaskawa representative or your Yaskawa sales representative if you are considering the application of this product for special purposes, such as machines or systems used for passenger cars, medicine, airplanes and aerospace, nuclear power, electric power, or undersea relaying.

⚠ WARNING *Injury to Personnel. Yaskawa manufactured this product with strict quality-control guidelines. Install applicable safety devices to minimize the risk of accidents when installing the product where its failure could cause a life-or-death situation, loss of human life, or a serious accident or physical injury.*

4 Moving the Drive

Obey local laws and regulations when moving and installing this product.

⚠ CAUTION *Crush Hazard. Do not hold the drive by the front cover or terminal cover. Tighten the screws correctly before moving the drive. Failure to obey can cause minor to moderate injury.*

Drive Weight	Persons Necessary to Move the Drive
< 15 kg (33 lbs.)	1
≥ 15 kg (33 lbs.)	2 + using appropriate lifting equipment

Refer to the drive Technical Manual for information about moving the drive with suspension systems, wires, or hanging metal brackets.

5 Receiving

Please check these items after receiving the drive:

- Examine the drive for damage. Immediately contact the shipping company if the drive is damaged. The Yaskawa warranty does not cover damage from shipping.
- Verify the drive model number in the "MODEL" section of the drive nameplate to make sure that you received the correct model.
- Contact your supplier if you receive the incorrect drive model or if the drive does not operate correctly.

◆ Nameplate

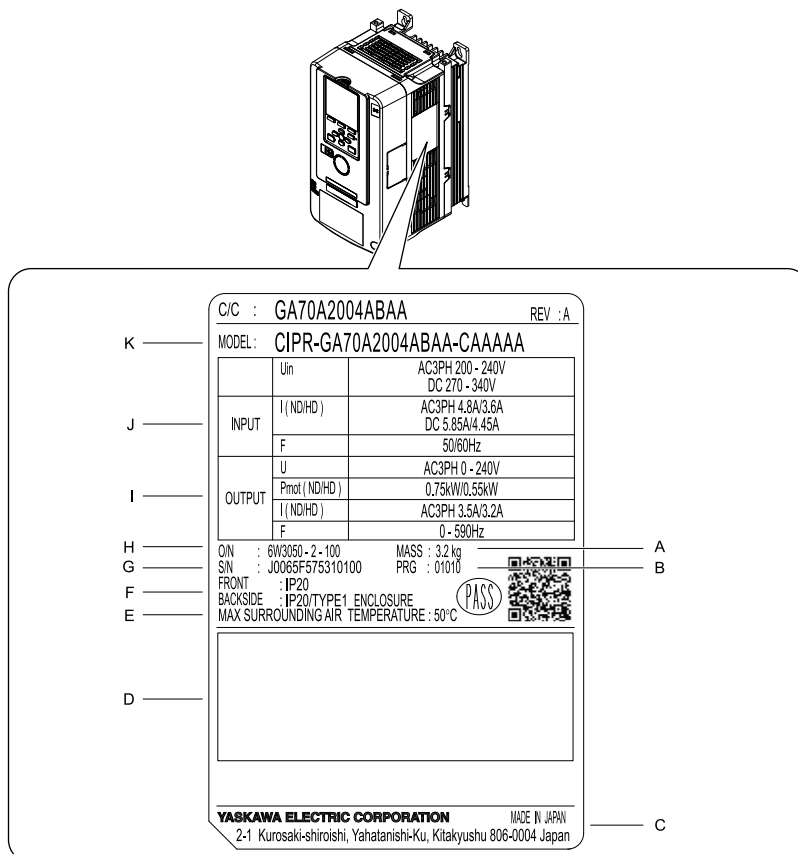

- | | |
|--|---------------------------|
| A - Mass | G - Serial number |
| B - Drive software version | H - Lot number |
| C - The address of the head office of Yaskawa Electric Corporation | I - Output specifications |
| D - Accreditation standards | J - Input specifications |
| E - Surrounding air temperature | K - Drive model |
| F - Protection design | |

Figure 5.1 Nameplate Information Example

6 Keypad

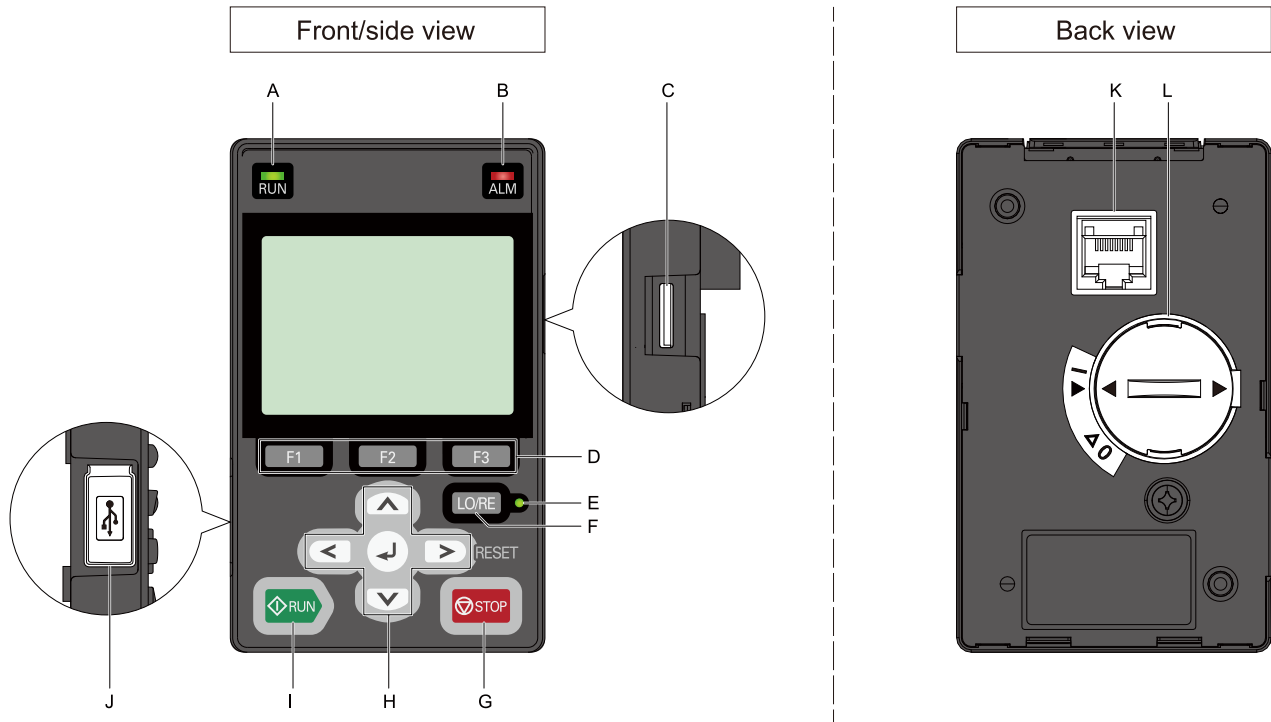





















Figure 6.1 Keypad

Table 6.1 Keypad: Names and Functions

-	Name	Functions
A	RUN LED 	Illuminates to show that the drive is operating the motor. The light turns off when the drive stops. Flashes to show that the drive: <ul style="list-style-type: none"> • Is decelerating to stop, or • Received a Run command, but the frequency reference is 0 Hz. Flashes quickly to show that the drive: <ul style="list-style-type: none"> • Received a Run command from the MFDI terminals and is switching to REMOTE Mode while the drive is in LOCAL Mode. • Received a Run command from the MFDI terminals when the drive is not in Drive Mode. • Received a Fast Stop command. • Output is shut off from the safety function. <ul style="list-style-type: none"> • Is operating in REMOTE Mode, and the user pushed  on the keypad. • Is energized with an active Run command and $b1-17 = 0$ [Run Command at Power Up = Disregard Existing RUN Command].
B	ALM LED 	Illuminates when the drive detects a fault. Flashes when the drive detects: <ul style="list-style-type: none"> • An alarm • An oPE parameter setting error • A fault or error during Auto-Tuning. The light turns off during regular drive operation without alarms or faults.
C	microSD Card Insertion Slot	The insertion point for a microSD card.
D	Function Keys F1, F2, F3 	The menu shown on the keypad sets the functions for  ,  , and  . The name of each function is in the lower half of the display window.

-	Name	Functions
E	LO/RE LED 	<p>Illuminates to identify when the drive is operating in LOCAL Mode.</p> <p>The keypad controls the Run command and frequency reference. Use the keypad to enter Run/Stop commands and the frequency reference command.</p> <p>The light turns off when the drive is operating in REMOTE Mode.</p> <p>The control circuit terminal or serial transmission device controls the Run command and frequency reference. Use the frequency reference source entered in <i>b1-01 [Frequency Reference Selection 1]</i> and the Run command source selected in <i>b1-02 [Run Command Selection 1]</i></p>
F	LO/RE Selection Key 	<p>Switches drive control for the Run command and frequency reference between the keypad (LOCAL) and an external source (REMOTE).</p> <p>Note:</p> <ul style="list-style-type: none"> • Stop operation in Drive Mode to enable the LO/RE Selection Key. Set <i>o2-01 = 0 [LO/RE Key Function Selection = Disabled]</i> to disable  when switching from REMOTE to LOCAL will have a negative effect on system performance. • The drive will not switch between LOCAL and REMOTE when it is receiving a Run command from an external source.
G	STOP Key 	<p>Stops drive operation.</p> <p>Note:</p> <p>Uses a stop-priority circuit.  will stop the drive quickly in LOCAL or REMOTE Mode. The drive will not stop with  when <i>o2-02 = 0 [STOP Key Function Selection = Disabled]</i>.</p>
H	Left Key 	Moves the cursor to the left.
	Up Arrow Key/Down Arrow Key 	<ul style="list-style-type: none"> • Scrolls up or down to show the next item or the previous item. • Selects parameter numbers. • Increments or decrements setting values.
	Right Key (Reset Key) 	<ul style="list-style-type: none"> • Moves the cursor to the right. • Continues to the next screen. • Clears drive faults.
	ENTER Key 	<ul style="list-style-type: none"> • Enters parameter values and settings. • Selects each mode, parameter, and set value. • Selects menu items to move the user between keypad displays.
I	RUN Key 	<p>Starts the drive in LOCAL Mode.</p> <p>Starts the motor tuning procedure when in Auto-Tuning Mode.</p> <p>Note:</p> <p>Push  on the keypad to set the drive to LOCAL Mode before using the keypad to operate the motor.</p>
J	USB Terminal	Insertion point for a mini USB cable. Use the mini USB cable to connect the drive to a PC.
K	RJ-45 Connector	Connects the keypad directly to the drive.
L	Clock Battery Cover	Cover for the customer-supplied clock battery.

EN

⚠ WARNING Sudden Movement Hazard. Remove all persons and objects from the area around the drive, motor, and machine area before switching control sources when *b1-07 = 1 [LOCAL/REMOTE Run Selection = Accept existing RUN command]*. Failure to obey can cause death or serious injury.

◆ Keypad Mode and Menu Displays

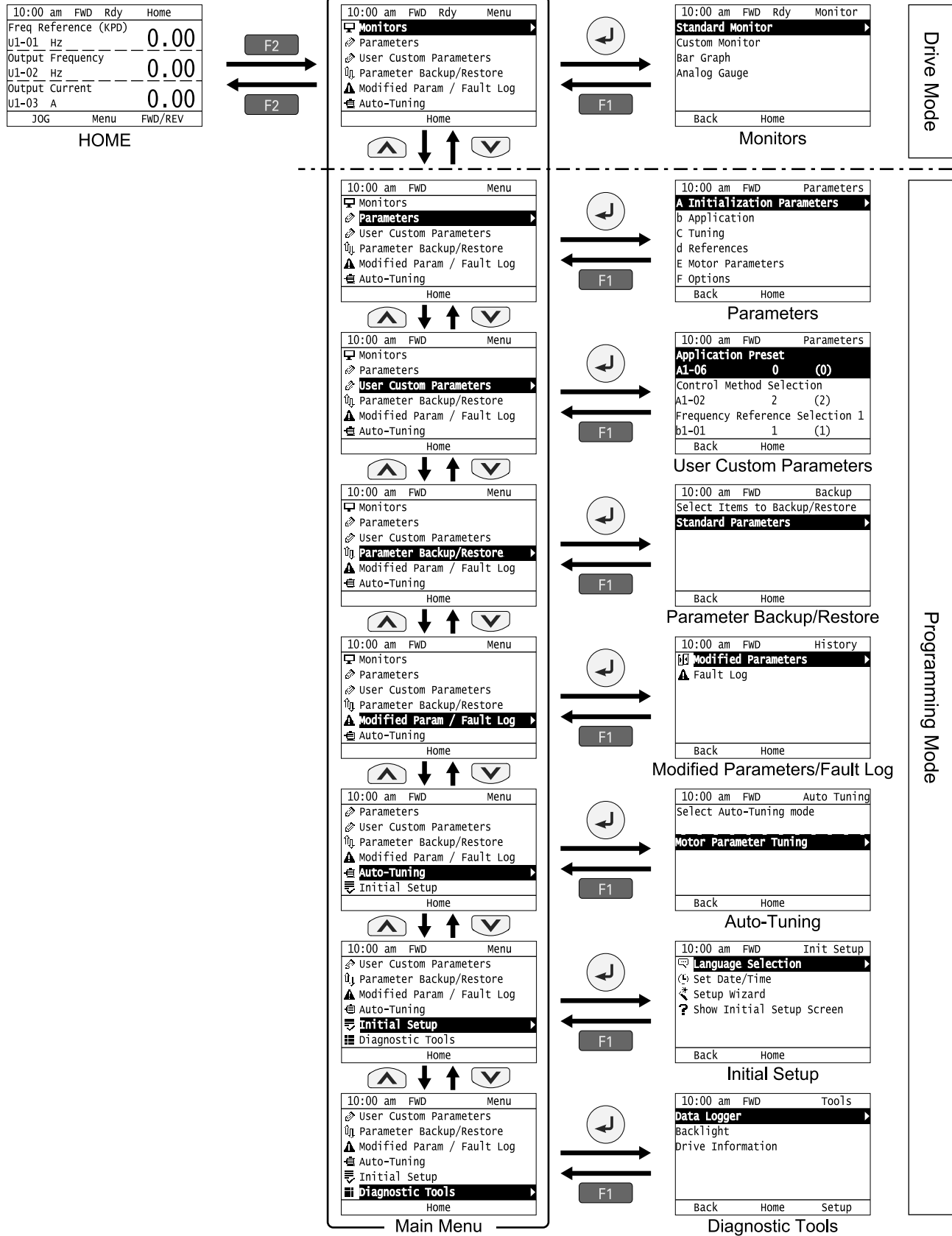

Figure 6.2 Keypad Functions and Display Levels

Note:



- Energize the drive with default settings to show the initial start-up screen. Push **F2** (Home) to show the HOME screen.
–Select [No] from the [Show Initial Setup Screen] setting to not display the initial start-up screen.
- Push  from the Home screen to show drive monitors.
- Push  to set *d1-01 [Reference 1]* when the Home screen shows *U1-01 [Frequency Reference]* in LOCAL Mode.
- The keypad will show [Rdy] when the drive is in Drive Mode and prepared to accept a Run command.
- The drive will not accept a Run command in Programming Mode. Set *b1-08 [Run Command Select in PRG Mode]* to accept or reject a Run command from an external source while in Programming Mode.
–Set *b1-08 = 0 [Disregard RUN while Programming]* to reject the Run command from an external source while in Programming Mode (default).
–Set *b1-08 = 1 [Accept RUN while Programming]* to accept the Run command from an external source while in Programming Mode.
–Set *b1-08 = 2 [Allow Programming only at Stop]* to prevent changes from Drive Mode to Programming Mode while the drive is operating.

Table 6.2 Drive Mode Screens and Functions

Mode	Keypad Screen	Function
Drive Mode	Monitors	Sets monitor display.
Programming Mode	Parameters	Changes parameter settings.
	User Custom Parameters	Displays the Frequently Used Parameters screen.
	Parameter Backup/Restore	Saves parameters to the keypad as backup.
	Modified Parameters / Fault Log	Shows modified parameters and fault history.
	Auto-Tuning	Auto-Tunes the drive.
	Initial Setup	Changes initial settings.
	Diagnostic Tools	Sets data logs and backlight.

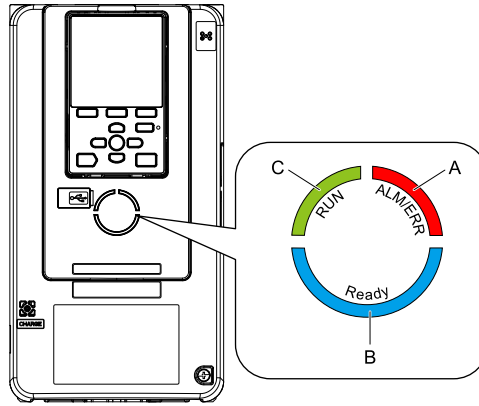

7 LED Status Ring

The LED Status Ring on the drive cover shows the drive operating status.



A - ALM/ERR
B - Ready

C - RUN

LED	State	Description
A	ALM/ERR	<p>Illuminated</p> <p>The drive detected a fault.</p> <p>Flashing</p> <p>The drive detects:</p> <ul style="list-style-type: none"> An alarm An <i>oPE</i> parameter setting error A fault or error during Auto-Tuning. <p>Note: The LED will illuminate to identify a fault if the drive detects a fault and an alarm at the same time.</p> <p>OFF</p> <p>The drive is in regular operation without alarms or faults.</p>
	Ready	<p>Illuminated</p> <p>The drive is operating or is prepared for operation.</p> <p>Flashing</p> <p>The drive is in <i>STo</i> [Safe Torque Off] Mode.</p> <p>OFF</p> <ul style="list-style-type: none"> The drive detects a fault. There is no fault and the drive received an operation command, but the drive cannot operate (such as when in Programming Mode, or when  is flashing).
		<p>Illuminated</p> <p>The drive is in regular operation.</p> <p>Flashing ^{*1}</p> <ul style="list-style-type: none"> When the drive is decelerating to stop. The drive received a Run command, but the frequency reference is 0 Hz. When the drive received a DC Injection Braking command. <p>Flashing Quickly ^{*1}</p> <ul style="list-style-type: none"> The drive received a Run command from the MFDI terminals and is switching to REMOTE Mode while the drive is in LOCAL Mode. The drive received a Run command from the MFDI terminals when the drive is not in Drive Mode. The drive received a Fast Stop command. The safety function shuts off the drive output. The user pushed  on the keypad when the drive is operating in REMOTE Mode. The drive is energized with an active Run command and <i>b1-17 = 0</i> [Run Command at Power Up = Disregard existing RUN command]. When the drive is set to coast-to-stop with timer (<i>b1-03 = 3</i> [Stopping Method Selection = coast to stop with timer]), the Run command was activated again during the Run wait time after once the Run command was disabled. <p>OFF</p> <p>The motor is stopped.</p>

*1 Refer to [Figure 7.1](#) for the difference between flashing and flashing quickly.

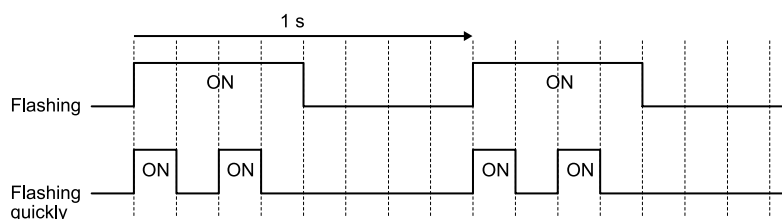

Figure 7.1 RUN LED Flashing Statuses

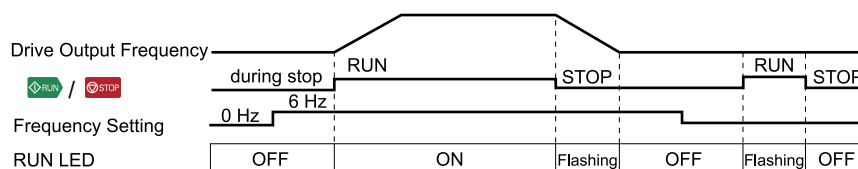

Figure 7.2 Relation between RUN LED and Drive Operation

8 Start-Up Procedure

1. Install and wire the drive.
2. Energize the drive.
3. Use A1-06 [Application Preset] to initialize the drive for a special application if necessary.
4. Run the set-up wizard to automatically set these functions:
 - Control Method Selection
 - Normal / Heavy Duty Selection
 - Motor Parameters
 - Speed reference source
 - Run command source
 - Acceleration and Deceleration Times
5. Run the motor without a load.
6. Make sure that the drive is operating correctly and make sure that the host controller is sending commands to the drive.
7. Connect the load.
8. Run the motor.
9. Make sure that the drive is operating correctly.
10. Fine-tune and set application parameters, such as PID.
11. Check final operation and make sure that parameter settings are correct.

The drive is prepared to run the operation.

9 Mechanical Installation

⚠ WARNING *Fire Hazard. Do not put flammable or combustible materials on top of the drive and do not install the drive near flammable or combustible materials. Attach the drive to metal or other noncombustible material. Failure to obey can cause death or serious injury.*

⚠ CAUTION *Crush Hazard. Do not hold the drive by the front cover or terminal cover. Tighten the screws correctly before moving the drive. Failure to obey can cause minor to moderate injury.*

Note:

Observe all necessary conditions to safely and correctly install the AC drive. Refer to the Technical Manual for more information.

NOTICE *Install the drive as specified by EMC Guidelines. Failure to obey can cause incorrect operation and damage to electrical devices.*

◆ Installation Position and Distance

Install the drive vertically for sufficient cooling airflow.

Note:

Contact Yaskawa or a Yaskawa representative for more information about installing drive models on their side.

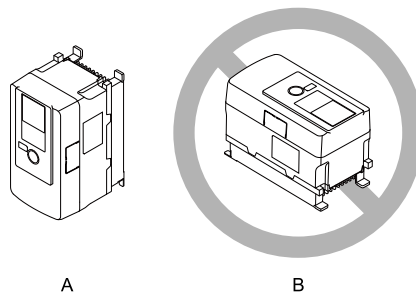

A - Vertical installation

B - Horizontal installation

Figure 9.1 Installation Position

■ Single Drive Installation

Use the clearances specified in [Figure 9.2](#) to install the drive. Make sure that there is sufficient space for wiring and airflow.

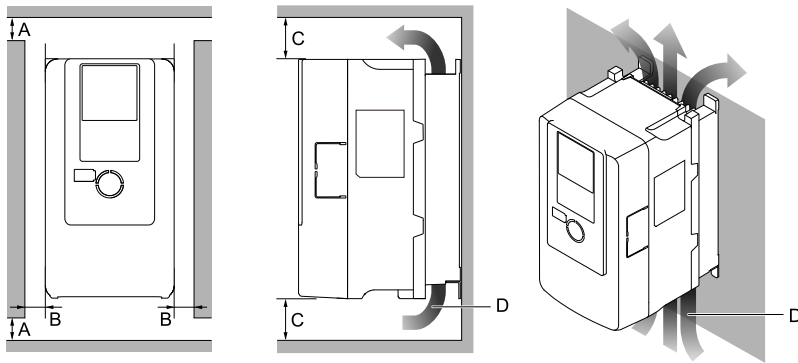

A - 50 mm (2 in.) minimum

B - 30 mm (1.2 in.) minimum on both sides

C - 120 mm (4.7 in.) minimum above and below

D - Airflow direction

Figure 9.2 Installation Distances for One Drive

■ Install Drives Side-by-Side

Users can install drive models 2004xB to 2082xB and 4002xB to 4044xB side-by-side.

Install the drives as specified by [Figure 9.3](#). Set L8-35 = 1 [*Installation Method Selection = Side-by-Side Mounting*].

Derate the output current to align with the ambient temperature.

Install other drive models as specified by [Figure 9.2](#)

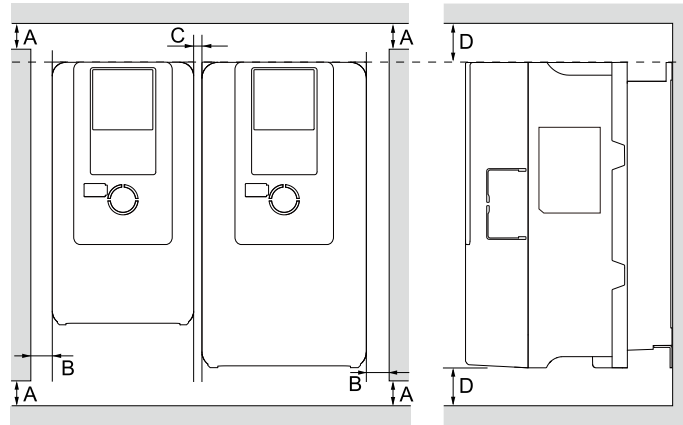

- A - 50 mm (2 in.) minimum**
B - 30 mm (1.2 in.) minimum on both sides
C - 2 mm (0.08 in.) minimum between each drive
D - 120 mm (4.7 in.) minimum above and below

Figure 9.3 Installation Distances for Multiple Drives (Side-by-Side)

Note:

- Align the tops of drives that have different dimensions to help when replacing cooling fans.
- Remove the top protective covers of all drives when mounting UL Type 1 enclosure drives side-by-side.

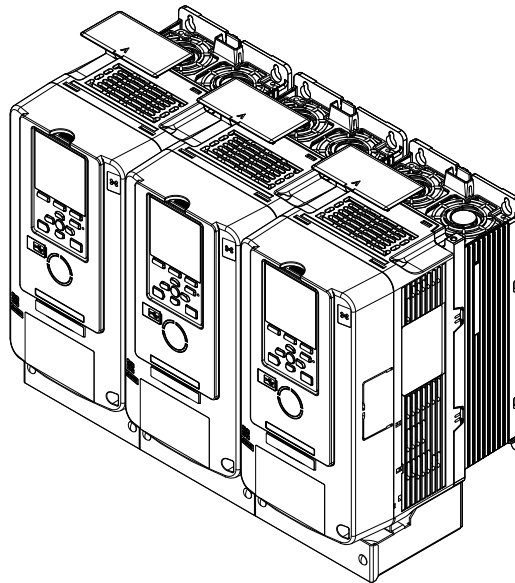

Figure 9.4 Enclosed Wall-Mounted Type (UL Type 1) Installed Side-by-Side

EN

◆ Installation Environment

The installation environment is crucial to ensure proper performance and the expected lifespan of the product. Ensure the installation environment satisfies the following specifications.

Environment	Conditions
Area of Use	Indoors
Power supply	Overvoltage Category III
Ambient Temperature Setting	<p>Open chassis type (IP20): -10°C to +50 °C (14 °F to 122 °F) Enclosed wall-mounted type (UL Type 1): -10 °C to +40 °C (14 °F to 104 °F)</p> <ul style="list-style-type: none"> • Drive reliability improves in environments without wide temperature fluctuations. • When using the drive in an control panel, install a cooling fan or air conditioner in the area to ensure that the air temperature inside the enclosure does not exceed the specified levels. • Do not allow ice to develop on the drive. • Derate the output current and output voltage to install the drive in areas with ambient temperatures up to 60 °C (140 °F).

Environment	Conditions
Humidity	95 RH% or less Do not allow condensation to develop on the drive.
Storage Temperature	-20 °C to +70 °C (-4 °F to +158 °F) (short-term temperature during transportation)
Surrounding Area	Pollution degree 2 or less Install the drive in an area free from: <ul style="list-style-type: none"> oil mist and dust metal powder, oil, water, or other foreign materials radioactive materials or flammable materials (e.x., wood) Harmful gases and liquids Low salinity Chlorides Keep wood or other flammable materials away from the drive.
Altitude	1000 m (3281 ft) maximum Note: Derate the output current by 1% for every 100 m (328 ft.) to install the drive in altitudes between 1000 m to 3000 m (3281 ft. to 9843 ft.). Rated voltage derating is not required: <ul style="list-style-type: none"> when installing the drive at 2000 m (6562 ft.) or lower if the drive is grounded with the neutral network when installing the drive at an altitude between 2000 m to 3000 m (6562 ft. to 9843 ft.) Contact Yaskawa or your nearest sales representative when the drive is not grounded with the neutral network.
Shock	<ul style="list-style-type: none"> 10 Hz to 20 Hz: 1 G (9.8 m/s², 32.15 ft/s²) 20 Hz to 55 Hz: 2004 to 2211, 4002 to 4168: 0.6 G (5.9 m/s², 19.36 ft/s²) 2257 to 2415, 4208 to 4675: 0.2 G (2.0 m/s², 6.56 ft/s²)
Installation Orientation	Install the drive upright to allow for proper cooling.

NOTICE Do not put drive peripheral devices, transformers, or other electronics near the drive. Shield the drive from electrical interference if components must be near the drive. Failure to obey can cause incorrect operation.

NOTICE Do not let unwanted objects, for example metal shavings or wire clippings, fall into the drive during drive installation and project construction. Put a temporary cover over the top of the drive during installation. Remove the temporary cover before start-up or the drive will overheat. Failure to obey can cause damage to the drive.

◆ Removing the Covers

Remove the covers according to the following procedure before wiring the drive.

⚠ DANGER *Electrical Shock Hazard. Do not examine, connect, or disconnect wiring on an energized drive. Before servicing, disconnect all power to the equipment and wait for the time specified on the warning label at a minimum. The internal capacitor stays charged after the drive is de-energized. The charge indicator LED extinguishes when the DC bus voltage decreases below 50 Vdc. When all indicators are OFF, remove the covers before measuring for dangerous voltages to make sure that the drive is safe. Failure to obey will cause death or serious injury.*

⚠ DANGER *Electrical shock Hazard. Disconnect the power to the drive and wait for the charge indicator LED to go off, then remove the covers. Failure to obey could cause death or serious injury.*

■ Remove the Front Cover

1. Push the hook on the top part of the keypad and pull forward to remove the keypad.
2. Remove the keypad connector and put it into the connector holder in the direction of the hook on the front cover.
3. Loosen the front cover screws.

Note:

The number of mounting screws are different for different drive models.

4. Unlock the tabs found on the sides of the front cover.

5. Carefully pull forward to remove the front cover.

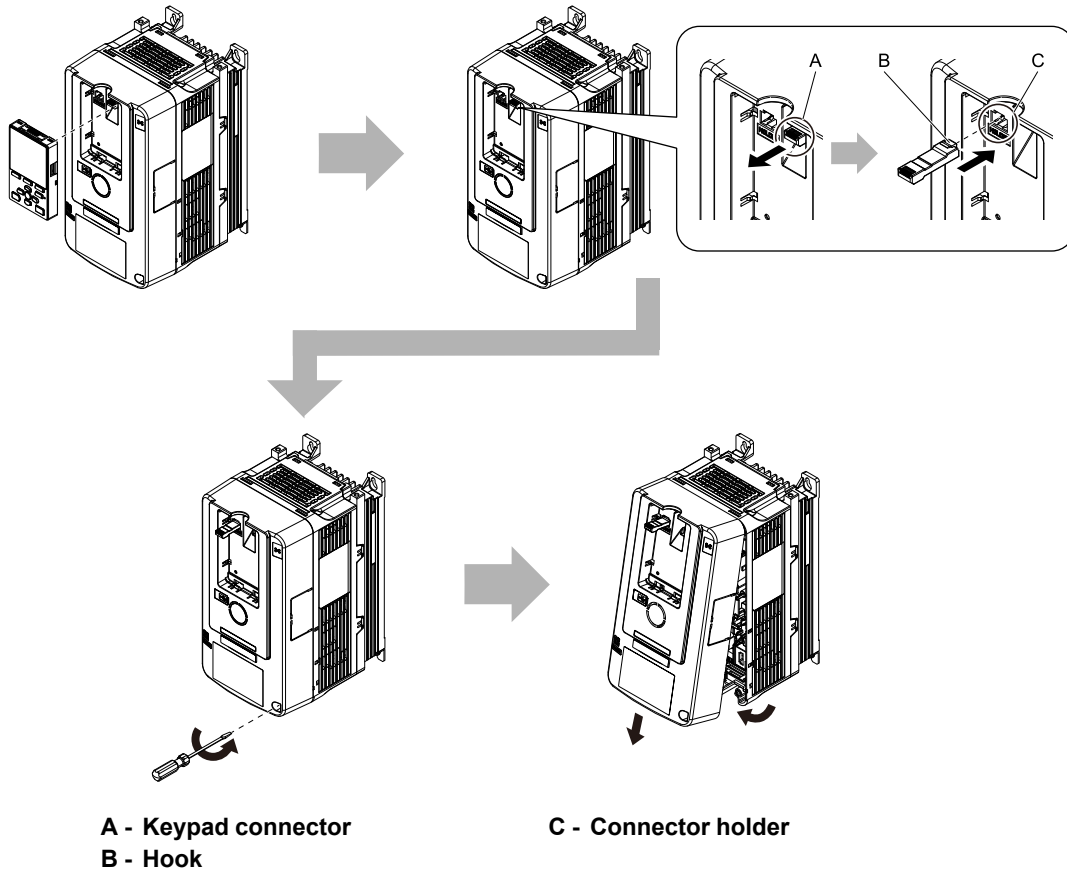
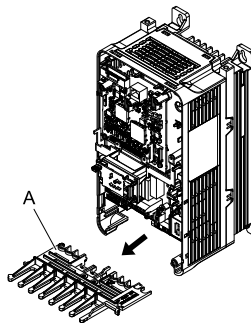

Figure 9.5 Remove the Front Cover

6. Remove the wiring cover before wiring the main circuit terminal.



■ Remove the Terminal Cover

1. Loosen the screws on the terminal cover.
2. Pull down on the cover.
3. Pull forward on the terminal cover to free it from the drive.

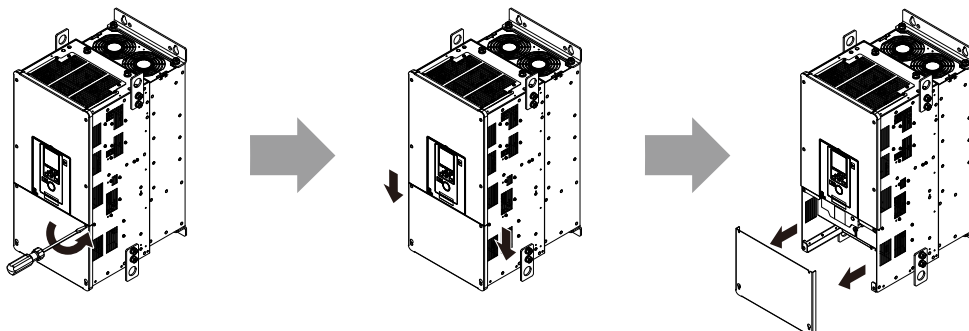
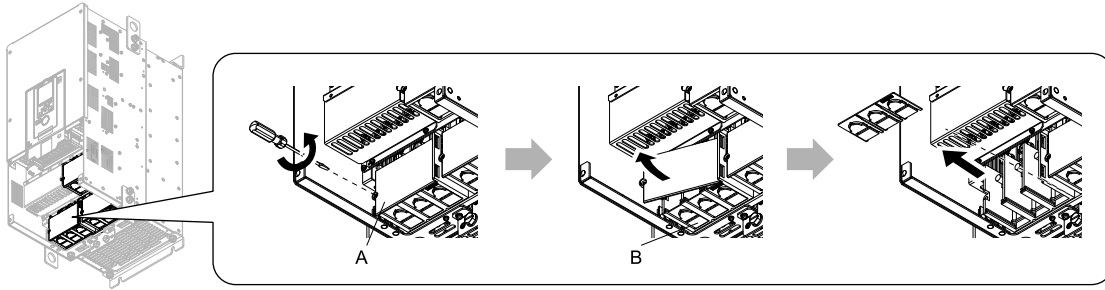

Figure 9.6 Removing the Terminal Cover

4. Remove the terminal wiring covers for wiring the main circuit terminals.



◆ Reattaching the Covers

Wire the drive, then reattach the covers before operating the drive.

■ Reattach the Front Cover

1. Reattach the wiring cover.

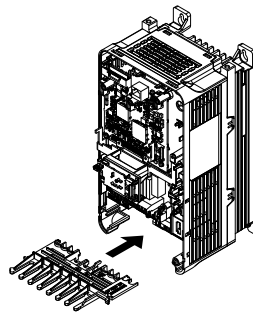

2. Reattach the front cover to the drive with the supplied screws.
3. Remove the keypad connector from the connector holder on the front cover.
4. Put the keypad connector into the connector on the drive in the direction of the hook.
5. Put the bottom part of the keypad into the drive first, then push the top part of the keypad into the drive to reattach the keypad.

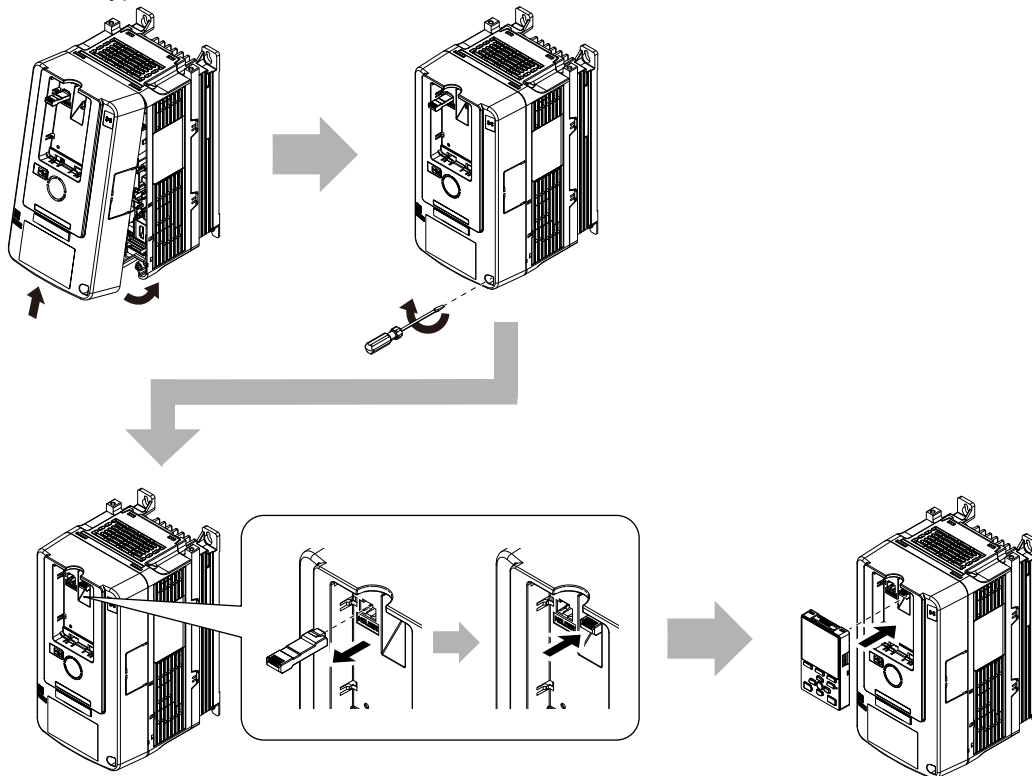

■ Reattach the Terminal Cover

1. Reattach the wiring cover.

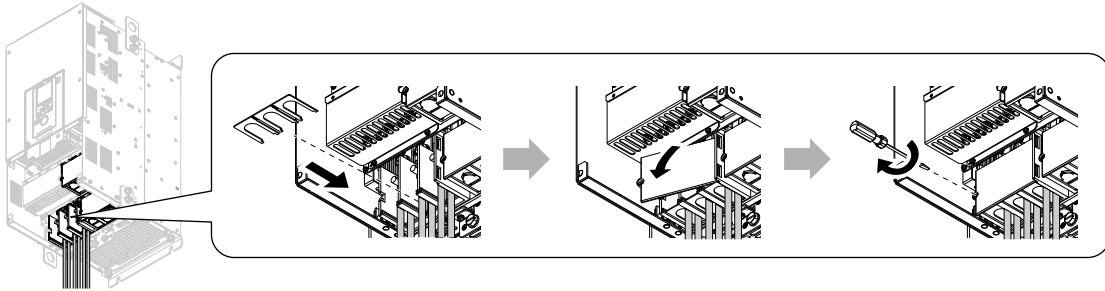

Note:

- The shape of the wiring cover differs depending on the drive model.
- Detach the cutaway section of the wiring cover by clipping only the areas that apply to the wired terminal. If areas that do not apply to the wired terminal are clipped, the protective enclosure will not maintain the IP20 protective level.
- Hold the cutaway section of the wiring cover firmly to prevent scattering when clipping this section. There is a risk of injury from scattering of the cutaway section.
- Process the cross section to prevent the cutaway section of the wiring cover from damaging the electric wires.
- If electrical wires other than those specified by Yaskawa are used, the protective enclosure may not maintain the IP20 protective level, even if the wiring cover is used correctly. Contact Yaskawa or your nearest sales representative for details.

2. Reattach the terminal cover to the drive using the supplied screws.

10 Electrical Installation

⚠ DANGER *Electrical Shock Hazard. Do not examine, connect, or disconnect wiring on an energized drive. Before servicing, disconnect all power to the equipment and wait for the time specified on the warning label at a minimum. The internal capacitor stays charged after the drive is de-energized. The charge indicator LED extinguishes when the DC bus voltage decreases below 50 Vdc. When all indicators are OFF, remove the covers before measuring for dangerous voltages to make sure that the drive is safe. Failure to obey will cause death or serious injury.*

⚠ DANGER *Electrical Shock Hazard. Make sure that all electrical connections are correct and install all drive covers before energizing the drive. Use terminals for their intended function only. Incorrect wiring or ground connections, and incorrect repair of protective covers can cause death or serious injury.*

⚠ WARNING *Electrical Shock Hazard. Correctly ground the drive before turning on the EMC filter switch. Failure to obey can cause death or serious injury.*

⚠ WARNING *Electrical Shock Hazard. Use the drive terminals only for their intended function. Refer to the drive Technical Manual for more information about I/O terminals. Incorrect wiring, incorrect grounding, and unsatisfactory repair of the protective cover could cause death or serious injury and damage to the drive.*

◆ Standard Connection Diagram

Wire the drive as shown in the following figure. If the drive is run using the keypad, the motor can be run by main circuit wiring.

⚠ WARNING *Sudden Movement Hazard. Set the multi-function input terminal parameters before closing the control circuit wiring. Incorrect Run/Stop circuit sequence settings can cause death or serious injury from moving equipment.*

⚠ WARNING *Sudden Movement Hazard. Correctly wire the start/stop and safety circuits before energizing the drive. Momentarily closing a digital input terminal can start a drive that is programmed for 3-Wire control. Failure to obey can cause death or serious injury from moving equipment.*

⚠ WARNING *Sudden Movement Hazard.*

When using a 3-Wire sequence:

- Set the drive for 3-Wire sequence.
- Set b1-17 = 0 [Run Command at Power Up = Disregard Existing RUN Command]
- Wire the drive for 3-Wire sequence.

The motor can rotate in reverse when energizing the drive if these three conditions are true:

- The drive is wired for 3-Wire sequence.
- The drive is set for a 2-Wire sequence (default).
- b1-17 = 1 [Accept Existing RUN Command]

Failure to obey can cause death or serious injury from moving equipment.

⚠ WARNING *Sudden Movement Hazard. Make sure that the drive I/O signals and external sequence are correct before entering the Application Preset function. Entering the Application Preset function or setting A1-06 ≠ 0 [Application Preset ≠ General-purpose] changes the drive I/O terminal functions and can cause sudden equipment operation. Failure to obey can cause death or serious injury.*

NOTICE *Fire Hazard. Install sufficient branch circuit short circuit protection as specified by applicable codes and this manual. The drive is suited for circuits that supply not more than 100,000 RMS symmetrical amperes, 240 Vac maximum (200 V Class), 480 Vac maximum (400 V Class). Failure to obey can cause death or serious injury.*

NOTICE *When the input voltage is 440 V or higher or if the wiring distance is longer than 100 m (328 ft.) be sure to use a drive duty motor or carefully monitor the motor insulation voltage. Failure to obey can cause damage to the motor insulation.*

NOTICE *Do not connect the AC control circuit ground to the drive enclosure. Failure to obey can cause incorrect control circuit operation.*

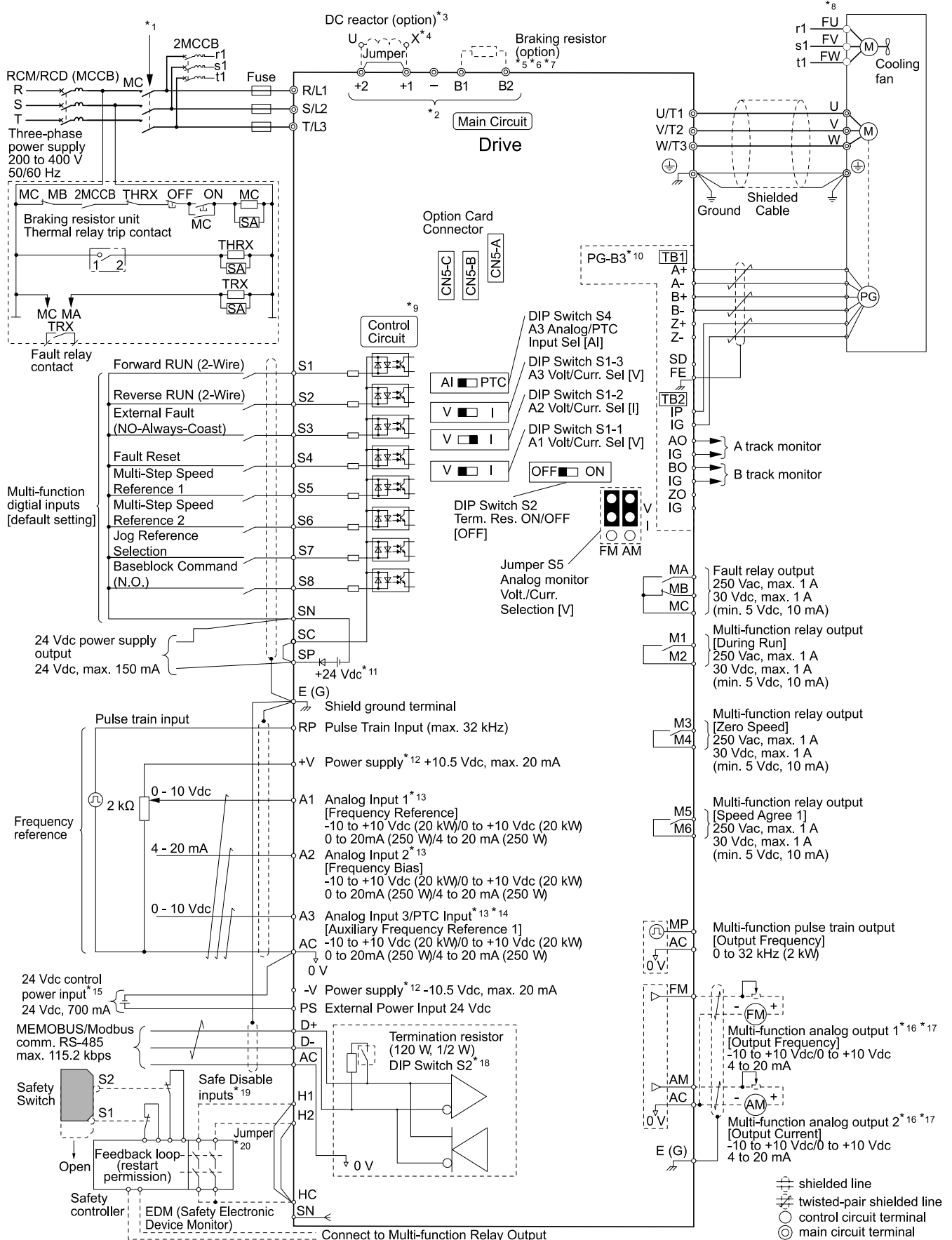

Figure 10.1 Standard Connection Diagram for the Drive

*1 We recommend that the sequence that shuts off the power source be set via the fault relay output for the drive. When using the Auto Restart function, if $L5-02 = 1$ [Auto Restart = Fault output active], the fault signal is output during Restart Enabled and the power supply will turn OFF. Use the interrupt sequence with caution. The default setting for $L5-02$ is 0 [Fault output not active].

*2 Terminals -, +1, +2, B1 and B2 are the optional connection terminals.

NOTICE Do not connect an AC power supply to terminals -, +1, +2, B1, and B2. Failure to obey can cause damage to the drive and peripheral devices.

*3 Be sure to remove the short bar between the terminals +1 and +2 when installing the optional DC reactor.

*4 Models 2110 to 2415 and 4060 to 4675 have a built-in DC reactor.

*5 Be sure to set $L8-55 = 0$ [*InternalBrakingTransistorProtect = Disable*] when using the regenerative converter, regenerative unit or the braking unit (when not using the built-in dynamic braking transistor). *rF* [*Braking Resistor Fault*] may be triggered.

*6 Set $L3-04 = 0$ [*Decel Stall Prevention Selection = Disabled*] to disable Stall Prevention when using a regenerative converter, regenerative unit, dynamic braking unit, braking resistor, or braking resistor unit. If left unchanged, it may not stop at the set deceleration time.

*7 When using a braking resistor (ERF type), set $L8-01 = 1$ [*Internal DB Resistor Protect Sel (ERF type) = Provided*] and be sure to use a sequence that shuts the power off by using the fault relay output for the drive.

*8 Wiring for the cooling fan motor is not required with the self-cooling motor.

*9 Supplying power to the control circuit separately from the main circuit requires a 24 V power supply be input to terminal PS-AC.

*10 Encoder circuit wiring (wiring on the PG-B3 option card) is not required when using the drive in an application that does not use feedback from the motor.

*11 Install a jumper between terminals SC-SP-SN to select the type of the power supply of MFDI.

NOTICE Do not short circuit terminals SP and SN. Failure to obey will cause damage to the drive.

- Sinking mode: Short terminals SC and SP.
- Sourcing mode: Short terminals SC and SN.
- External power supply: No jumper necessary.

*12 The maximum output current capacity of the +V and -V terminals on the control circuit terminal is 20 mA.

NOTICE Do not install a jumper between terminals +V, -V, and AC. Failure to obey can cause damage to the drive.

*13 Set DIP switches S1-1 to S1-3 to select between a voltage or current input command to terminals A1 to A3. The default setting for S1-1 and S1-3 is voltage reference input ("V" side). The default setting for S1-2 is current reference input ("I" side).

*14 Set DIP switch S4 to select between an analog input or PTC input to terminal to A3. After the PTC input has been selected, set DIP switches S1-3 to the V side, and set $H3-05 = 0$ [*0-10V (LowLim=0)*].

*15 Do not connect terminals PS and AC inversely. Failure to comply will damage the drive.

*16 Monitor outputs work with devices such as analog frequency meters, ammeters, voltmeters, and wattmeters. They are not intended for use as a feedback-type of signal.

*17 Set jumper switch S5 to select between a voltage or current output to terminals FM and AM. The default setting is V-side (voltage output).

*18 Enable the termination resistor in the last drive in a MEMOBUS/Modbus communications by setting DIP switch S2 to the ON position.

*19 Use sourcing mode for Safe Disable input.

*20 Disconnect the wire jumper between H1 - HC and H2 - HC when utilizing the Safe Disable input.

◆ Wire Gauge and Torque Specifications

Be sure to select the correct wires for the main circuit wiring.

Refer to the Technical Manual for main circuit wire gauges and tightening torques as specified by European standards and UL standards.

■ Main Circuit Wire Gauges and Tightening Torques

Use the tables in this section to select the appropriate wires. Use shielded wire when wiring the control circuit terminal block. For simpler and more reliable wiring, use crimp ferrules on the wire ends.

The tightening torque for the control circuit terminal is displayed on the reverse side of the front cover.

Table 10.1 Main Circuit Wire Gauges and Tightening Torques

Terminal	Bare Wire		Crimp Ferrule	
	Recommended Gauge mm ² (AWG)	Applicable Gauge mm ² (AWG)	Recommended Gauge mm ² (AWG)	Applicable Gauge mm ² (AWG)
S1-S8, SC, SN, SP H1, H2, HC RP, +V, -V, A1, A2, A3, AC MP, FM, AM, AC D+, D-, AC MA, MB, MC, M1-M6 PS, E(G)	0.75 (18)	<ul style="list-style-type: none"> Stranded wire 0.2 to 1.0 (24 - 18) Solid wire 0.2 to 1.5 (24 - 16) 	0.5 (20)	0.25 to 0.5 (24 - 20)

Crimp Ferrule

Always attach an insulated sleeve when using crimp ferrules. Refer to the following table for the recommended external dimensions of the crimp ferrule and the model number.

Use the CRIMPFOX 6, a crimping tool manufactured by PHOENIX CONTACT.

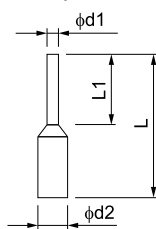

Figure 10.2 External Dimensions of Crimp Ferrule

Table 10.2 Crimp Ferrules Models and Sizes

Wire Gauge mm ² (AWG)	Model	L (mm)	L1 (mm)	d1 (mm)	d2 (mm)
0.25 (24)	AI 0.25-8YE	12.5	8	0.8	2.0
0.34 (22)	AI 0.34-8TQ	12.5	8	0.8	2.0
0.5 (20)	AI 0.5-8WH, AI 0.5-8OG	14	8	1.1	2.5

Line Voltage Drop

⚠ WARNING *Electrical Shock Hazard. The leakage current of drive models 4389A to 4675A, 2xxxB/C and 4xxxB/C is more than 3.5 mA. The IEC/EN 61800-5-1: 2007 standard specifies that users must wire the power supply to automatically turn off when the protective ground wire disconnects. Users can also connect a protective ground wire that has a minimum cross-sectional area of 10 mm² (copper wire) or 16 mm² (aluminum wire). Failure to obey these standards can cause death or serious injury.*

Be sure to think about line voltage drop before selecting wire gauges.

Select wire gauges that drop the voltage by 2% or less of the rated voltage. Increase the wire gauge and the cable length when the risk of voltage drops increases.

Calculate line voltage drop with this formula:

$$\text{Line voltage drop (V)} = \sqrt{3} \times \text{wire resistance } (\Omega/\text{km}) \times \text{wiring distance (m)} \times \text{motor rated current (A)} \times 10^{-3}$$

Dynamic Braking Precautions

Connect braking units to drives with these conditions:

- Models with built-in braking transistors use terminals B1 and -
- Models without built-in braking transistors use terminals +3 and -.

NOTICE *Review the Braking Unit and Braking Resistor Unit Installation Manual TOBPC72060001 for wire gauge and tightening torque information before connecting a dynamic braking option to the drive. Failure to obey can cause damage to the drive and braking circuit.*

Connect a regenerative converter or regenerative unit with terminals +1 and -.

NOTICE *Do not connect a braking resistor to terminals +1 or -. Failure to obey can cause damage to the drive circuitry.*

◆ Wiring the Main Circuit and Motor

Refer to [Figure 10.3](#) for a view of the drive with line and load wiring.

⚠ WARNING *Electrical Shock Hazard. Do not connect terminals R/L1, S/L2, T/L3, U/T1, V/T2, W/T3, -, +1, +2, +3, B1, or B2 to the ground terminal. Failure to obey can cause death, serious injury, or damage to equipment.*

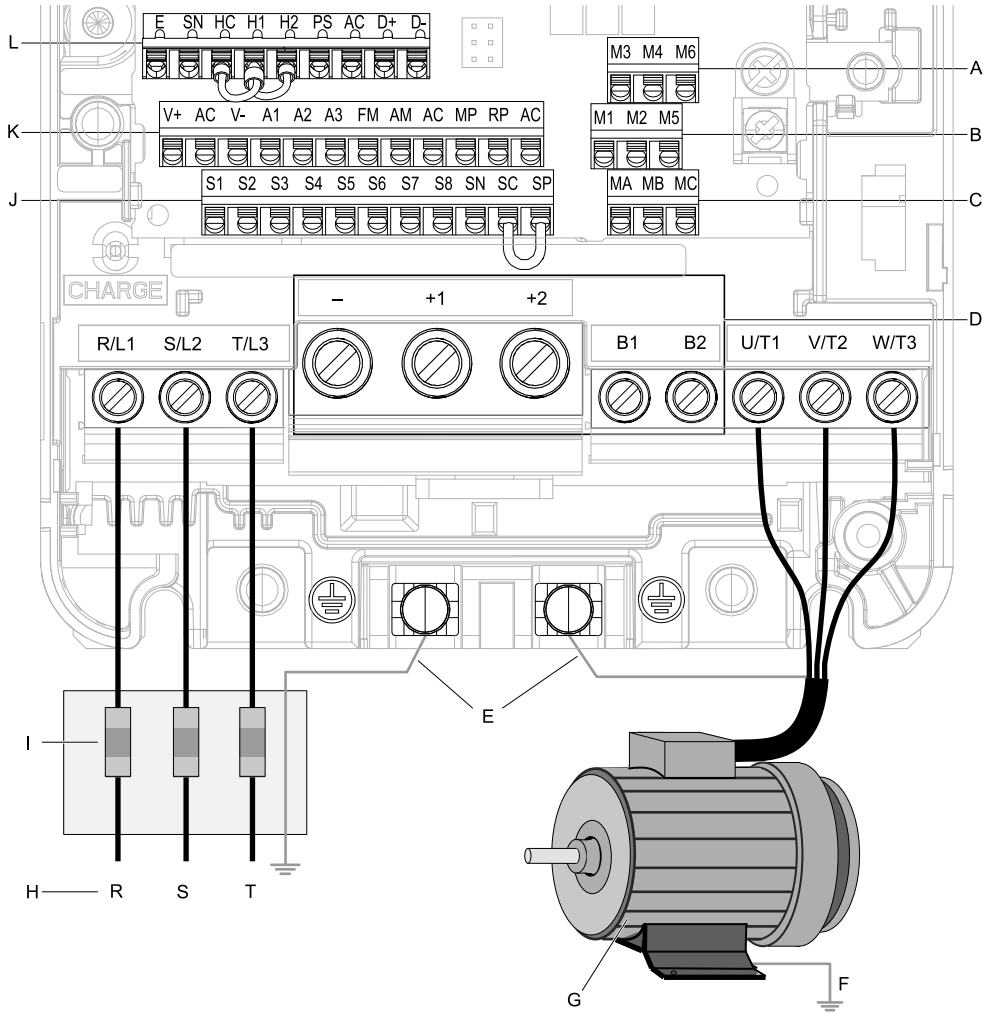

- A - Terminal block (TB2-3)
- B - Terminal block (TB2-2)
- C - Terminal block (TB2-1)
- D - DC bus voltage terminals (configuration changes by drive model)
- E - Drive ground terminals
- F - Motor case ground
- G - Three-phase motor
- H - Three-phase power supply
- I - Fuses and RCD
- J - Terminal block (TB1)
- K - Terminal block (TB3)
- L - Terminal block (TB4)

Figure 10.3 Wiring the Line and Load

11 Drive Start-Up

◆ Setup Wizard

Locate and record the following information before starting the drive. Refer to the drive and motor nameplates for details.

Item	Value
Motor Rated Power	kW
Motor Rated Voltage	V
Motor Rated Current	A

Item	Value
Motor Rated Frequency	Hz
Motor Maximum Frequency	Hz
Motor Pole Count	
Motor Base Rotation Speed	min ⁻¹
Number of Encoder Pulses	ppr

Follow the Setup Wizard procedures to prepare the drive for operation. The Setup Wizard requires motor data to perform Auto-Tuning and test runs.

1. Energize the drive to display the initial start-up screen.

Note:

If the keypad does not show the initial setup screen, push **F2** [Menu] to show the Menu screen then push  to select [Initial Setup].

2. Select [Set Date/Time] to set the date and time.

Note:

Insert a battery in the keypad to enable the clock functions. Use a Hitachi Maxell CR2016 manganese dioxide lithium battery or an equivalent battery with the following characteristics:

- Nominal voltage: 3 V
- Work temperature range: -20°C to +85°C (-4°F to +185°F)
- Nominal battery life: 2 years (20 °C (68 °F) ambient temperature)

3. Select [Setup Wizard] and follow the instructions on the keypad.



Drive and motor preparation is finished when the setup wizard is complete.

◆ Auto-Tuning

Auto-Tuning automatically sets parameters on the drive connected to the motor.

⚠ WARNING *Sudden Movement Hazard. Disconnect the load from the motor when performing Rotational Auto-Tuning. Failure to comply could cause death or serious injury and damage machinery.*

To start Auto-Tuning:

1. Select [Auto-Tuning] then select the Auto-Tuning Mode.
2. Use the information in [Table 11.1](#) and [Table 11.2](#) to select [Auto-Tuning Mode Selection] or [EZ Tuning Mode Selection], depending on the application.
3. Enter motor data.
4. Push  to start Auto-Tuning.

Refer to the Technical Manual for more information on Auto-Tuning.

Table 11.1 Auto-Tuning Mode Selection

Mode	T1-01 Setting	Application Conditions and Benefits	A1-02 = 0 [V/f]	A1-02 = 2 [OLV]
Rotational Auto-Tuning	0	Recommended tuning mode for the most accurate results. Select this tuning method when: <ul style="list-style-type: none"> • Users can decouple the motor from the load. • Users cannot decouple the motor from the load, but the motor load is less than 30%. 	-	YES
Stationary Auto-Tuning	1	Automatically calculates motor parameters for vector control. Select this tuning mode when: <ul style="list-style-type: none"> • Users cannot decouple the motor from the load. • The motor test report data is not available. 	-	YES
Stationary Line-Line Resistance	2	Select this tuning mode when: <ul style="list-style-type: none"> • The drive and motor capacities are different. • The drive is in V/f Control. • Replacing the drive and motor. 	YES	YES

Table 11.2 EZ Tuning Mode Selection

Mode	T4-01 Setting	Application Conditions and Benefits	A1-02 = 8 [EZOLV]
Motor Parameter Setting	0	Sets motor parameters.	YES
Line-to-Line Resistance	1	Select this tuning mode after replacing the drive, motor, and motor cables.	YES

◆ Change Parameter Settings

The procedure below shows how to change the *C1-01 [Acceleration Time 1]* setting. Use this procedure to set parameters for other applications.

1. Push **F2** [Home] to show the HOME screen.

Note:

- The keypad will show [Home] in the top right corner when the HOME screen is active.
- If [Home] is not on **F2**, push **F1** [Back].

2. Push **F2** [Menu].

10:00 am	FWD	Rdy	Home
Freq Reference (AI)			
U1-01	Hz		0.00
Output Frequency			
U1-02	Hz		0.00
Output Current			
U1-03	A		0.00
JOG	Menu	FWD/REV	

3. Push **▲** or **▼** to select [Parameter], then push **↵**.



10:00 am	FWD	Menu
Monitors		
Parameters		
User Custom Parameters		
Parameter Backup/Restore		
Modified Param / Fault Log		
Auto-Tuning		
Home		

4. Push **▲** or **▼** to select [C Tuning], then push **↵**.

10:00 am	FWD	Parameters
A	Initialization Parameters	
b	Application	
C	Tuning	
d	References	
E	Motor Parameters	
F	Options	
Back	Home	

5. Push  or  to select [C1 Accel & Decel Time], then push .



10:00 am	FWD	Parameters
C1 Accel & Decel Time		
C2 S-Curve Characteristics		
C3 Slip Compensation		
C4 Torque Compensation		
C6 Duty & Carrier Frequency		
Back	Home	

6. Push  or  to select C1-01, then push .

10:00 am	FWD	Parameters
Acceleration Time 1		
C1-01	10.0	(10.0)sec
Deceleration Time 1		
C1-02	10.0	(10.0)sec
Acceleration Time 2		
C1-03	10.0	(10.0)sec
Back	Home	

7. Push  or  to select the specified digit. Push  or  to select the correct number.

10:00 am	FWD	Parameters
Acceleration Time 1		
C1-01	00 10.0	sec
Default : 10.0sec		
Range : 0.0~6000.0		
Back	Default	Min/Max

- Push  [Default] to set the parameters to the factory default.
- Push  [Min/Max] to move between the minimum value and maximum value.

8. Push  to keep the changes.

10:00 am	FWD	Parameters
Acceleration Time 1		
C1-01	0020 .0	sec
Default : 10.0sec		
Range : 0.0~6000.0		
Back	Default	Min/Max

9. Continue to set parameters or push  [Back] to go back to the HOME screen.

12 Drive Control, Duty Modes, and Programming

EN

◆ Drive Control Methods

This section gives information about these basic motor control methods:

- V/f Control (V/f)
- Open Loop Vector control (OLV)
- EZ Vector Control for induction motors only (EZOLV)

Refer to the Technical Manual for information about speed feedback and Permanent Magnet/Synchronous Reluctance motor control methods.

Use parameter *A1-02* [Control Method Selection] to set the correct motor control method for the application.

Control Method	A1-02 Setting	Main Applications
V/f	0 (default)	<ul style="list-style-type: none"> General variable-speed Operating more than one motor from one drive When replacing the motor without motor parameter values.
OLV	2	<ul style="list-style-type: none"> General variable-speed High precision and speed control without speed feedback
EZOLV	8	<ul style="list-style-type: none"> General variable-speed No high precision, no speed control, and no speed feedback

◆ Drive Duty Modes

The drive has two duty modes from which to select for the application: Heavy Duty (HD) and Normal Duty (ND). The duty rating name switches to *[Normal Duty 2 Rating]* or *[Heavy Duty 2 Rating]* when *E1-01 [Input AC Supply Voltage] ≥ 460 V*.

Refer to [Table 12.1](#) for information about the differences between HD and ND ratings.

Table 12.1 Drive Duty Modes

C6-01 [Normal / Heavy Duty Selection]	E1-01 [Input AC Supply Voltage]	C6-01 Setting	Application	Default Carrier Frequency	oL2 [Drive Overload]
Heavy Duty Rating (HD1)	<ul style="list-style-type: none"> ≥ 200 V and < 240 V ≥ 380 V and < 460 V 	0	<ul style="list-style-type: none"> Extruder Conveyor Constant torque or high overload capacity 	2 kHz	150% rated output current for 60 s
Heavy Duty 2 Rating (HD2)	≥ 460 V and < 480 V				
Normal Duty Rating (ND1)	<ul style="list-style-type: none"> ≥ 200 V and < 240 V ≥ 380 V and < 460 V 	1	<ul style="list-style-type: none"> Fan Pump Blower Variable speed control 	2 kHz Swing-PWM	110% rated output current for 60 s
Normal Duty 2 Rating (ND2)	≥ 460 V and < 480 V				

◆ Drive Parameters

Refer to the table when setting the most important parameters.

Note:

Users can change parameters with "RUN" in the "No." column during Run.

No. (Hex.)	Name	Description
A1-00 (0100) RUN	Language Selection	Sets the language for the LCD keypad. 0: English, 1: Japanese, 2: Deutsch, 3: Français, 4: Italiano, 5: Español, 6: Português, 7: Chinese, 8: Czech, 9: Russian, 10: Turkish, 11: Polish, 12: Greek
A1-02 (0102)	Control Method Selection	Sets the control method for the drive application and the motor. 0: V/f Control, 1: V/f Control w/ PG, 2: Open Loop Vector, 3: Closed Loop Vector, 4: Advanced Open Loop Vector, 5: PM Open Loop Vector, 6: PM Advanced Open Loop Vector, 7: PM Closed Loop Vector, 8: EZ Vector Control
A1-03 (0103)	Initialize Parameters	Sets parameters to default values. 0: No Initialization, 1110: User Initialization, 2220: 2-Wire initialization, 3330: 3-Wire initialization
b1-01 (0180)	Frequency Reference Selection 1	Sets the input method for the frequency reference. 0: Keypad, 1: Analog Input, 2: MEMOBUS/Modbus Communications, 3: Option PCB, 4: Pulse Train Input
b1-02 (0181)	Run Command Selection 1	Sets the input method for the Run command. 0: Keypad, 1: Digital Input, 2: Memobus/Modbus Communications, 3: Option PCB
b1-03 (0182)	Stopping Method Selection	Sets the method to stop the motor after removing a Run command or entering a Stop command. 0: Ramp to Stop, 1: Coast to Stop, 2: DC Injection Braking to Stop, 3: Coast to Stop with Timer, 9: Stop with Constant Distance

No. (Hex.)	Name	Description
b1-04 (0183)	Reverse Operation Selection	Enables and disables reverse operation. Disable reverse operation in fan or pump applications where reverse rotation is dangerous. 0: Reverse Enabled, 1: Reverse Disabled
C1-01 (0200) RUN	Acceleration Time 1	Sets the length of time to accelerate from zero to maximum output frequency.
C1-02 (0201) RUN	Deceleration Time 1	Sets the length of time to decelerate from maximum output frequency to zero.
C2-01 (020B)	S-Curve Time @ Start of Accel	Sets the time to start S-curve acceleration.
C2-02 (020C)	S-Curve Time @ End of Accel	Sets the time to complete S-curve acceleration.
C2-03 (020D)	S-Curve Time @ Start of Decel	Sets the time to start S-curve deceleration.
C2-04 (020E)	S-Curve Time @ End of Decel	Sets the time to complete S-curve deceleration.
C6-01 (0223)	Normal / Heavy Duty Selection	Sets the drive duty rating. 0: Constant Torque Application Heavy Duty Rating 1 (HD1 / HD2), 1: Variable Torque Application Normal Duty Rating 1 (ND1 / ND2)
C6-02 (0224)	Carrier Frequency Selection	Sets the carrier frequency for the transistors in the drive. 1: 2.0 kHz, 2: 5.0 kHz (4.0 kHz), 3: 8.0 kHz (6.0 kHz), 4: 10.0 kHz (8.0 kHz), 5: 12.5 kHz (10.0 kHz), 6: 15.0 kHz (12.0 kHz), 7: Swing PWM1 (Audible Sound 1), 8: Swing PWM2 (Audible Sound 2), 9: Swing PWM3 (Audible Sound 3), A: Swing PWM4 (Audible Sound 4), F: User Defined (C6-03 to C6-05)
d1-01 - d1-16 (0280 - 0291) RUN	Reference 1 to 16	Sets the frequency reference in the units from <i>o1-03 [Frequency Display Unit Selection]</i> .
d1-17 (0292) RUN	Jog Reference	Sets the Jog frequency reference in the units from <i>o1-03 [Frequency Display Unit Selection]</i> . Set <i>H1-xx = 6 [Terminal Sx Function Selection = Jog Reference Selection]</i> to use the Jog frequency reference.
d2-01 (0289)	Frequency Reference Upper Limit	Sets maximum limit for all frequency references. This value is a percentage of <i>E1-04 [Maximum Output Frequency]</i> .
d2-02 (028A)	Frequency Reference Lower Limit	Sets minimum limit for all frequency references. This value is a percentage of <i>E1-04 [Maximum Output Frequency]</i> .
E1-01 (0300)	Input AC Supply Voltage	Sets the drive input voltage. Set this parameter to the nominal voltage of the AC power supply.
E1-04 (0303)	Maximum Output Frequency	Sets the maximum output frequency for the V/f pattern.
E1-05 (0304)	Maximum Output Voltage	Sets the maximum voltage for the V/f pattern.
E1-06 (0305)	Base Frequency	Sets the base frequency for the V/f pattern.
E1-09 (0308)	Minimum Output Frequency	Sets the minimum output frequency for the V/f pattern.
E2-01 (030E)	Motor Rated Current	Sets the motor rated current in amps.
E2-11 (0318)	Motor Rated Power (kW)	Sets the motor rated power in 0.01 kW units. (1 HP = 0.746 kW)
H1-01 - H1-08 (0438, 0439, 0400 - 0405)	Terminal Sx Function Selection	Sets the functions for MFDI terminals S1-S8.

12 Drive Control, Duty Modes, and Programming

No. (Hex.)	Name	Description
H2-01 (040B)	Term M1-M2 Function Selection	Sets the function for MFDO terminal M1-M2.
H2-02 (040C)	Term M3-M4 Function Selection	Sets the function for MFDO terminal M3-M4.
H2-03 (040D)	Term M5-M6 Function Selection	Sets the function for MFDO terminal M5-M6.
H3-01 (0410)	Terminal A1 Signal Level Select	Sets the input signal level for MFAI terminal A1. 0: 0 to 10 V (Lower Limit at 0), 1: -10 to +10 V (Bipolar Reference), 2: 4 to 20 mA, 3: 0 to 20 mA
H3-02 (0434)	Terminal A1 Function Selection	Sets the function for MFAI terminal A1.
H3-03 (0411) RUN	Terminal A1 Gain Setting	Sets the gain for the analog signal input to MFAI terminal A1.
H3-04 (0412) RUN	Terminal A1 Bias Setting	Sets the bias of the analog signal input to MFAI terminal A1.
H3-05 (0413)	Terminal A3 Signal Level Select	Sets the input signal level for MFAI terminal A3. 0: 0 to 10 V (Lower Limit at 0), 1: -10 to +10 V (Bipolar Reference), 2: 4 to 20 mA, 3: 0 to 20 mA
H3-06 (0414)	Terminal A3 Function Selection	Sets the function for MFAI terminal A3.
H3-07 (0415) RUN	Terminal A3 Gain Setting	Sets the gain of the analog signal input to MFAI terminal A3.
H3-08 (0416) RUN	Terminal A3 Bias Setting	Sets the bias of the analog signal input to MFAI terminal A3.
H3-09 (0417)	Terminal A2 Signal Level Select	Sets the input signal level for MFAI terminal A2. 0: 0 to 10 V (Lower Limit at 0), 1: -10 to +10 V (Bipolar Reference), 2: 4 to 20 mA, 3: 0 to 20 mA
H3-10 (0418)	Terminal A2 Function Selection	Sets the function for MFAI terminal A2.
H3-11 (0419) RUN	Terminal A2 Gain Setting	Sets the gain of the analog signal input to MFAI terminal A2.
H3-12 (041A) RUN	Terminal A2 Bias Setting	Sets the bias of the analog signal input to MFAI terminal A2.
H3-13 (041B)	Analog Input FilterTime Constant	Sets the time constant for primary delay filters on MFAI terminals.
H3-14 (041C)	Analog Input Terminal Enable Sel	Sets which Sx terminal is enabled when $H1-xx = C$ [Terminal Sx Function Selection = Analog Terminal Enable Selection]. Also sets which Sx terminal is disabled when the input is OFF. 1: Terminal A1 only, 2: Terminal A2 only, 3: Terminals A1 and A2, 4: Terminal A3 only, 5: Terminals A1 and A3, 6: Terminals A2 and A3, 7: Terminals A1, A2, and A3
H4-01 (041D)	Terminal FM Analog Output Select	Sets which drive monitor $Ux-xx$ to output from MFAO terminal FM.
H4-02 (041E) RUN	Terminal FM Analog Output Gain	Sets the gain of the $Ux-xx$ monitor signal in $H4-01$.

No. (Hex.)	Name	Description
H4-03 (041F) RUN	Terminal FM Analog Output Bias	Sets the bias of the U_{x-xx} monitor signal in <i>H4-01</i> .
H4-04 (0420)	Terminal AM Analog Output Select	Sets which drive monitor U_{x-xx} to output from MFAO terminal AM.
H4-05 (0421) RUN	Terminal AM Analog Output Gain	Sets the gain of the U_{x-xx} monitor signal in <i>H4-04</i> .
H4-06 (0422) RUN	AM Analog Output Bias	Sets the bias of the monitoring signal that is output from the MFAO terminal AM as a percentage. Set the level of the analog signal output from the AM terminal at 10 V (or 20 mA) as 100% when an output for monitoring items is 0%
H4-07 (0423)	Terminal FM Signal Level Select	Sets the output signal level from MFAO terminal FM. 0: 0 to 10 Vdc, 1: -10 to +10 Vdc, 2: 4 to 20 mA
H4-08 (0424)	Terminal AM Signal Level Select	Sets the output signal level from MFAO terminal AM. 0: 0 to 10 Vdc, 1: -10 to +10 Vdc, 2: 4 to 20 mA
L1-01 (0480)	Motor Overload (oL1) Protection	Sets the motor overload protection function that uses electronic thermal protectors. 0: Disabled, 1: Variable Torque, 2: Constant Torque 10:1 Speed Range, 3: Constant Torque 100:1 SpeedRange, 4: PM Variable Torque, 5: PM Constant Torque, 6: Variable Torque (50Hz)
L1-02 (0481)	Motor Overload Protection Time	Sets the motor thermal overload protection (oL1) time. Usually it is not necessary to change this setting.
L3-04 (0492)	Stall Prevention during Decel	Sets the method that the drive will use to prevent overvoltage faults when decelerating. 0: Disabled, 1: General Purpose, 2: Intelligent (Ignore Decel Ramp), 3: General Purpose w/ DB resistor, 4: Overexcitation/High Flux, 5: Overexcitation/High Flux 2

13 Faults and Alarms

Look at the drive keypad for fault and alarm information if the drive or motor do not operate correctly.



For drive alarms:

- Keypad shows the alarm code
-  and ALM/ERR on the LED Status Ring flash.
- The drive will continue to operate the motor. Some alarms let the user select a motor stopping method.

For drive faults:

- Keypad shows the fault code
-  and ALM/ERR on the LED Status Ring stay illuminated.
- The drive shuts off output, the fault relay output turns ON, and the motor coasts to stop.

◆ Fault Reset Procedure

1. Remove the cause of the fault or alarm.
2. Push  (Reset) or  on the keypad while the keypad is showing the fault or alarm code.

This table lists the most frequent alarms and faults with possible causes and solutions.

Refer to the Technical Manual for a full list of faults and alarms.

Code	Name	Causes	Possible Solutions
bb	Baseblock	A digital input set for the software baseblock function is OFF and the drive will not accept a Run command.	<ul style="list-style-type: none"> • Make sure that the digital input function selections are correct. • Make sure that the host controller sequence is correct.
CrST	Cannot Reset	Tried to reset a fault when a Run command was active.	Stop the Run command and reset the drive.

13 Faults and Alarms

EF	FWD/REV Run Command Input Error	A forward command and a reverse command were input at the same time for longer than 500 ms.	Make sure that the sequence is correct. Do not set the forward and reverse inputs at the same time.
EF1 to EF8	External Fault (Terminal Sx)	One of the digital inputs caused an external fault through an external device. The digital input settings are incorrect.	<ul style="list-style-type: none"> Find the device that caused the external faults. Remove the cause and reset the fault. Make sure that the digital input terminal functions are correct.
GF	Ground Fault	A current short to ground was more than 50% of the rated current on the output side of the drive.	<ul style="list-style-type: none"> Make sure that the output wiring is correct. Make sure that the motor does not have short circuits or damaged insulation.
		The motor wiring or insulation are damaged.	Replace damaged parts.
		Too much parasitic capacitance at drive output.	Reduce the carrier frequency in <i>C6-02 [Carrier Frequency Selection]</i> .
STo	Safe Torque OFF	The two Safe Disable inputs are open. The drive output is safely disabled and the motor will not start.	<ul style="list-style-type: none"> Find the problem causing the host controller safety device to disable the drive. If the Safe Disable function does not disable the drive or if it is not used for the ISO/EN 13849-1 (PL e (Cat.III)), and IEC/EN 61508 (SIL3), connect a jumper between terminals HC, H1, and H2.
SToF	Safe Torque OFF Hardware	Opening only one Safe Disable input disables drive output. (Usually inputs H1 and H2 must open to disable drive output.) <ul style="list-style-type: none"> One input is damaged and will not switch off after removing the external signal. The host controller switched off one input. 	<ul style="list-style-type: none"> Make sure that the wiring from the host controller is correct and the controller set the two signals correctly. If the signals are correct and the alarm continues to occur, replace the drive.
oC	Overcurrent	<ul style="list-style-type: none"> There is a short circuit or ground fault on the drive output side. The load is too heavy. The accel/decel times are too short. The motor data is incorrect. The V/f pattern settings are incorrect. A magnetic contactor was switched at the output. 	<ul style="list-style-type: none"> Replace damaged output wiring and motor wiring. Repair damaged machine parts. Make sure that the drive parameter settings are correct. Make sure that the output contactor sequence is correct.
oL1	Motor Overload	The motor load is too heavy.	Decrease the motor load.
		Operating a general-purpose motor slower than the rated speed with a high load.	Use a motor with external cooling and set the correct motor type in <i>L1-01 [Motor Overload (oL1) Protection]</i> .
		Cycle times are too short during acceleration and deceleration.	Increase the acceleration and deceleration times.
		The motor rated current setting is incorrect.	Make sure that the motor rated current in <i>E2-01 [Motor Rated Current (FLA)]</i> is correct.
oL2	Drive Overload	<ul style="list-style-type: none"> The load is too heavy. The drive capacity is too small. Torque is too high at low speed. 	<ul style="list-style-type: none"> Examine the load. Make sure that the drive is sufficiently large for the load. The overload capability of the drive decreases at low speeds. Decrease the load or replace the drive with a larger capacity model.
ov	Overvoltage	<ul style="list-style-type: none"> The DC bus voltage is too high. The deceleration time is too short. Stall prevention is disabled. The braking resistor is missing or damaged. Motor control is not stable. The input voltage is too high. 	<ul style="list-style-type: none"> Increase the deceleration time. Set <i>L3-04 [Stall Prevention during Decel] ≠ 0</i> to enable stall prevention. Replace the braking resistor. Make sure that motor parameter settings are correct and adjust torque and slip compensation if necessary. Make sure that the power supply voltage meets drive specifications.

PF	Input Phase Loss	Drive input power has an open phase.	Correct all wiring errors in the main circuit drive input power.
		The drive input power terminals are not tight.	Tighten the terminals to the correct tightening torque.
		Too much fluctuation in the drive input power voltage.	<ul style="list-style-type: none"> • Measure the voltage from the drive input power. • Make the drive input power stable.
		There is unsatisfactory balance between voltage phases.	<ul style="list-style-type: none"> • Make the drive input power stable. • Disable phase loss detection.
		The main circuit capacitors are unserviceable.	<ul style="list-style-type: none"> • Make sure that the capacitor maintenance time in monitor <i>U4-05 [CapacitorMaintenance]</i> is less than 90%. • Replace the main capacitors if <i>U4-05</i> is more than 90%. Contact Yaskawa or a Yaskawa representative to replace the main capacitors.
		Make sure that there are no problems with the drive input power. If drive input power is correct and the alarm continues to occur, replace the control board or the drive. Contact Yaskawa or a Yaskawa representative to replace the control board.	

14 Disposal Instructions

Correctly discard the drive, packing material, battery, and microSD card as specified by regional, local, and municipal laws and regulations for this product. (Example: European Waste 16 02 14)

Note:

- Remove the battery and microSD card from the keypad before discarding the drive.
- The battery is not recyclable. Discard used batteries as specified by the battery manufacturer.
- Customers are responsible for microSD card data protection. PC functions that format and delete the data may not be sufficient to fully erase the microSD card data.
Yaskawa recommends that customers physically destroy the microSD card in a shredder or use data wipe software to fully erase the card.

YASKAWA AC Drive GA700

High Performance Type Initial Steps

YASKAWA EUROPE GmbH

Hauptstraße 185, 65760 Eschborn, Germany

Phone: +49-6196-569-500

E-mail: support@yaskawa.eu.com

Internet: <http://www.yaskawa.eu.com>

DRIVE CENTER (INVERTER PLANT)

2-13-1, Nishimiyaichi, Yukuhashi, Fukuoka, 824-8511, Japan

Phone: +81-930-25-2548 Fax: +81-930-25-3431

Internet: <http://www.yaskawa.co.jp>

YASKAWA AMERICA, INC.

2121, Norman Drive South, Waukegan, IL 60085, U.S.A.

Phone: +1-800-YASKAWA (927-5292) or +1-847-887-7000 Fax: +1-847-887-7310

Internet: <http://www.yaskawa.com>

YASKAWA

YASKAWA ELECTRIC CORPORATION

In the event that the end user of this product is to be the military and said product is to be employed in any weapons systems or the manufacture thereof, the export will fall under the relevant regulations as stipulated in the Foreign Exchange and Foreign Trade Regulations. Therefore, be sure to follow all procedures and submit all relevant documentation according to any and all rules, regulations and laws that may apply.

Specifications are subject to change without notice for ongoing product modifications and improvements.

© 2016 YASKAWA Electric Corporation

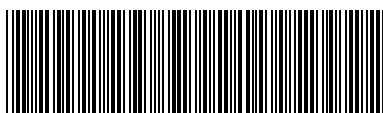

TOEPC71061717

MANUAL NO. TOEP C710617 17B <1>-0
Published in Japan September 2016
15-11-8_YEU
Original instructions